

Highly Accurate Two Color Online Infrared Non-Contact Pyrometer (700°C to 1700°C

IR-CAST 2C

IR-CAST 2C is a highly accurate digital two colour Rectangular measuring field IR pyrometer for non contact temperature measurement specially used in foundries for molten metal. The Pyrometer measures the temperature of an object by calculating the ratio of the energies at two different wavelength bands. The ratio technique eliminates and reduces errors in temperature measurement caused by factors such as dust, vapour or smoke etc.

If the target is within this rectangular area, it gives an accurate temperature reading even when liquid moves within this area.

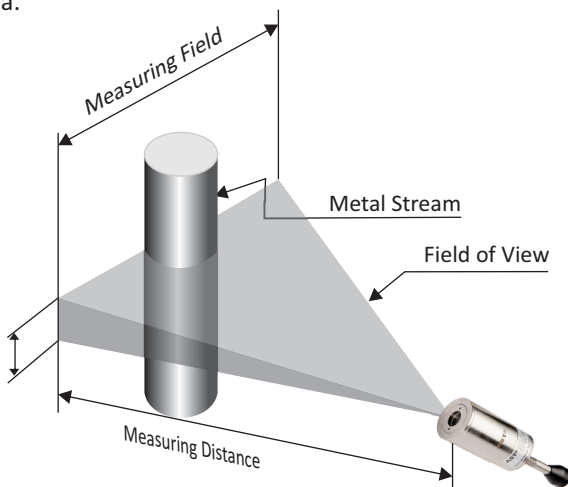

Technical Specifications

| Model | IR-CAST 2C |
|---|---|
| Temperature Range (Analog sub-range adjustable) | 700°C....1700°C |
| Spectral Range | 0.7....1.15 μm |
| Photodetector Type | Si/Si |
| Distance to Spot Size Ratio | D _v = 166:1 (V = Vertical) D _h = 33:1 (H = Horizontal) |
| Emissivity (ε) | 0.1....1.0 adjustable (Single color mode) |
| Emissivity Slope (ε ₁ / ε ₂) | 0.75...1.25 slope adjustable (Two color mode) |
| Response Time | 20 msec adjustable upto 10 sec |
| Accuracy | ± 0.5% of the measured value + 1°C |
| Repeatability | 0.1% of reading in °C + 1°C |
| Sighting Options | Through The Lens (TL) |
| Analog Output | 0-20mA, 4-20mA, 0-10V (User selectable) |
| Digital Output | USB 2.0 RS-232/RS-485 (User selectable) *At a time only one digital output possible |
| Operating Temp. Range | 0°C.....70°C 0°C.....200°C (With water cooling jacket) |
| Storage Temp. Range | -20°C...70°C |
| Adjustable Parameters and Features via Software | Emissivity, Emissivity Slope, Response Time, Clear Time(Peak Picker), Analog Output, Analog Scale(Sub range),Sensor type (Switches b\w 2-color or single color), Switch off level, Unit Of Temperature(°C/°F), Communication mode(Comm.mode), Record feature etc |
| Power Supply | 24V DC |
| Power Consumption | Max 2.5 watt |
| Laser Power | <1 m watt |
| Protection Class | IP65 |
| Housing | Stainless Steel |
| Isolation | Power supply, *Digital output and Analog output are galvanically isolated against each other * Not applicable for USB 2.0 digital output |
| Operating Humidity | 10-95%, Non-Condensing Conditions |
| Weight & Dimensions | 600g Dia= Ø 49.5 mm; Length=118mm |





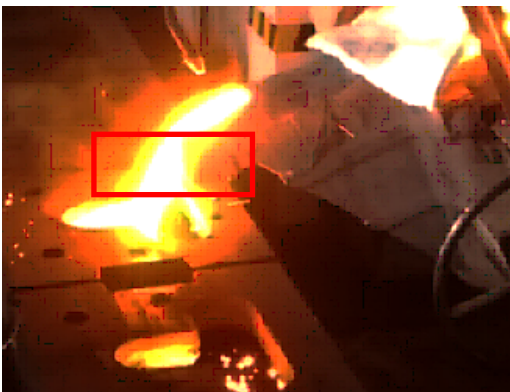

Features

- Rectangular field of view for molten metal.
- Wide temperature ranges from 700°C to 1700°C.
- Spectral range 0.7 μm....1.15 μm
- Fast response time within milliseconds
- Two Color model
- Through the lens view finder sighting options
- Analog output options available like 0...20mA, 4...20mA and 0...10V
- USB2.0 Digital output and RS-232/RS-485 Serial interface
- User friendly PC software for communication



We measure accurate temperature in extreme conditions

Spot Sizes

| Manufactured working distances WD (mm) | Spot Sizes (mm) | | Measuring Field |
|--|------------------------|-----------------------|---|
| | 700° - 1700°C | | |
| | FOV _v 166:1 | FOV _H 33:1 | |
| 350 | 2.1 | 10.5 |  |
| 500 | 3 | 15 |  |
| 700 | 4.2 | 21 |  |
| 1000 | 6 | 30 |  |
| 2000 | 12 | 60 |  |
| 3000 | 18 | 90 |  |
| 5000 | 30 | 150 |  |
| Aperture (A) | 4 | | |

Standard Scope of Supply

- Pyrometer with Through the lens(TL) sighting
- Analog output 4...20mA, 0..20mA, 0..10V
- USB 2.0 Digital output, USB Cable
- Digital Interface RS-232 / RS-485(user selectable)
- 5 mtr long connection cable with connector
- 1.5 mtr. Communication Cable
- Calibration certificate, Software & Operation manual

Optional

- Mechanical & Electrical Accessories
- Extra Cable Lengths

Applications

- Molten Metal

Software “Infrasoft”

AST “Infrasoft “ software is under standard scope of supply. It offers possibilities of connecting three pyrometers simultaneously for parameter setting, view real time graph, offline graph and to evaluate measuring data. Communication between the pyrometer and the software is implemented via a cable connected between the pyrometer and the PC serial port. It comes with record feature, spot size calculator and parameter settings features.

Some of the parameters adjustable via software are

- Emissivity, Response Time,
- Clear Time(Peak Picker),
- Analog Output,
- Sub Range,
- Unit Of Temperature(°C/°F),
- Communication mode(Comm.mode).

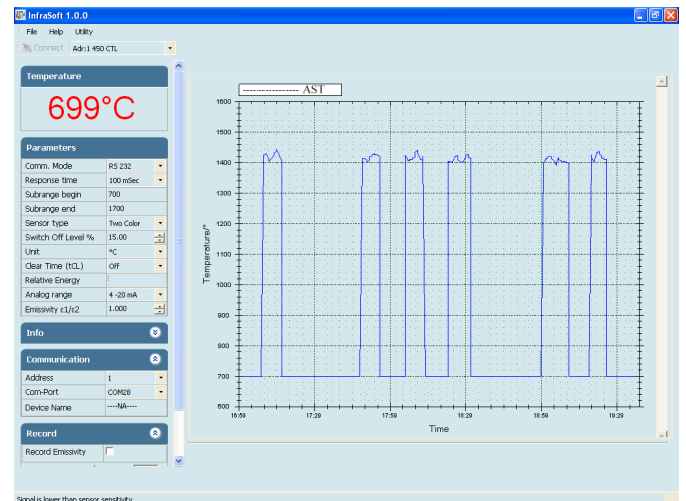



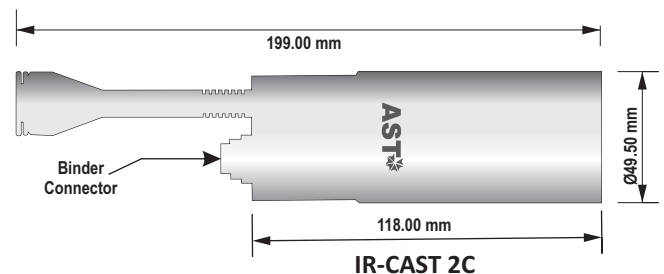
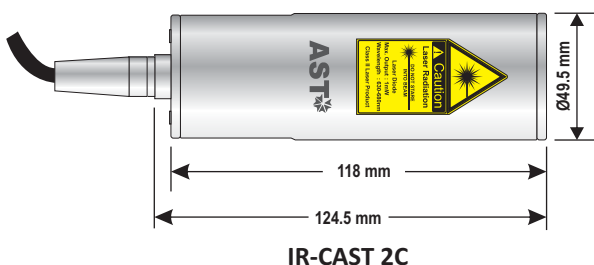



Pyrometer Drawing

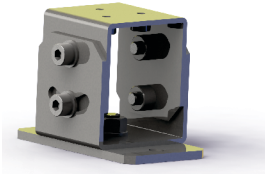

We measure accurate temperature in extreme conditions

Accessories

| | | | |
|---|---|--|---|
| <p>Water Cooling Jacket (Reference no: 8000-06)</p> | <p>Adjustable Mounting Stand (Reference no: 8000-07)</p> | <p>Air Purge Unit (Reference no: 8000-04)</p> | <p>Adjustable Mounting Support (Reference no: 8000-05)</p> |
|  |  |  |  |
| <p>Display & Parameterizer P-120 (Reference no: 9001-01)</p> | <p>Converter RS-232 ↔ RS-485 (Reference no: 9000-03)</p> | <p>Power supply Input 110/230V AC Reference No. 9000 - 02 Output 24 V DC, 0.7Amp.</p> | <p>Temperature Indicator (Reference no: 9000-01)</p> |
|  |  |  |  |

Pyrometer Accessories Drawings

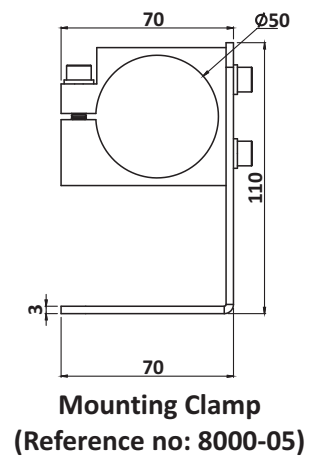
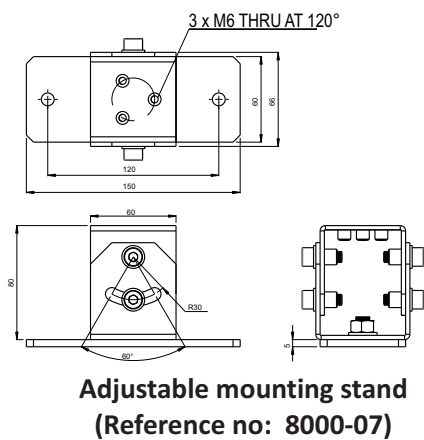
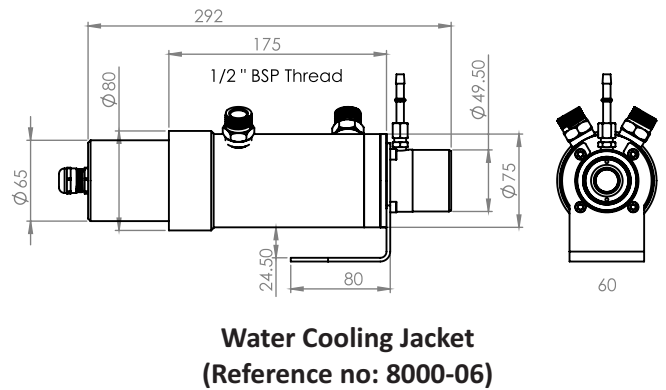
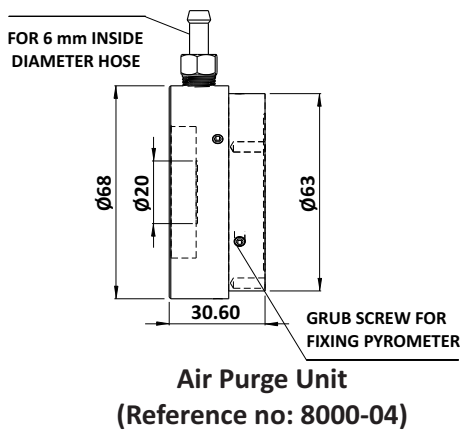

Accurate Sensors Technologies Pvt. Ltd.
Misgav Industrial Park, Misgav 20174 Israel
Phone : +972-4-9990025, Fax : +972-4-9990031
E-mail : info@accuratesensors.com

Accurate Sensing Technologies Pvt. Ltd.
188A, B-169 (Part), B-188 (A), Road No. - 5, M. I. A.,
Madri, Udaipur (Rajasthan) - 313003
Phone : +91-294-3507736, Fax : +91-294-3507731
Email : sales@accuratesensors.com

