

REX-P48 REX-P96



General Description

The REX-P48 (1/8DIN) and REX-P96 (1/4DIN) are user-friendly ramp/soak controllers that can store two sets of patterns with accuracy of 0.3%. Each pattern can have up to eight segments. Two patterns can be linked so that a program with up to 16 segments can be stored.

Optional digital input as well as key operation enables you to run, stop and hold the program, and skip the segment.

Time signal output or pattern end output is also available. With these functions accompanied by external instruments, REX-P48/96 provides easy operation for complicated temperature control.

Features

- ☆ Easy-to-use ramp/soak controller
- ☆ Two sizes of 1/4DIN and 1/8DIN
- ☆ 2 patterns, maximum 16 segments/program
- ☆ Time signal output, pattern end signal output
- ☆ Digital input for operation mode selection
- ☆ Retransmission output

Easy-to-use

Simple key operation enables you to use the REX-P48/96 for various applications where easy-to-use is critical.

Each key has a specific role for operation so that the REX-P48/96 can eliminate operator's mistake.

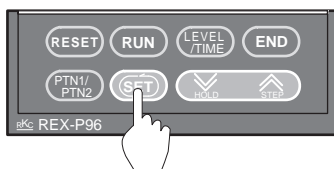

Four groups of PID

Up to four groups of PIDs can be stored so that you can use appropriate PIDs for different temperature ranges.

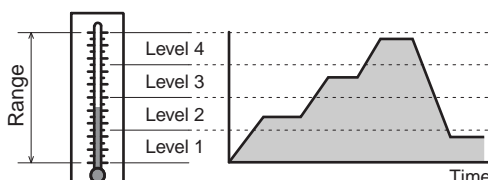

Pattern link function

Up to 16 ramp/soak segments per program are available simply by linking the second pattern (program) to the first.

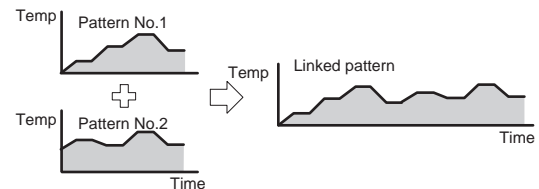

Fixed set point control

The unlimited time can be set for soak segments so that fixed setpoint control can be obtained easily.

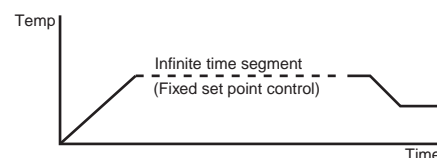

Options

- Time signal output/Pattern end output: Two time signal outputs per pattern can be set.
- Digital input for operation mode selection among RUN, STOP, STEP and HOLD
- Retransmission output
- Two alarms

Ramp/Soak temperature controller REX-P48/96

Specifications

Input

Input

- a) Thermocouple : K, J, R, S, B, E, T, N (JIS/IEC), PLII (NBS)
W5Re/W26Re (ASTM), U, L (DIN)
Influence of external resistance : Approx. $0.35\mu\text{V}/\Omega$
Input break action : Up-scale
- b) RTD : Pt100 (JIS/IEC), JPt100 (JIS)
Influence of input lead resistance : Approx. $0.0075\%/ \Omega$ of reading
• Maximum 10Ω per wire
Input break action : Up-scale

Sampling time
0.5 sec

PV bias
-1999 (-199.9) to 9999 (999.9)°C [°F]

PV ratio
0.001 to 9.999

Performance

Measuring accuracy

- \pm (0.3% of span + 1 digit)
Cold junction temperature error
Within $\pm 1.5^\circ\text{C}$ (between 0 and 50°C [32 and 122°F])
• Accuracy is not guaranteed between 0 and 400°C (0 and 752°F) for type B input.
• Accuracy is not guaranteed between 0 and 32°F for Type N, PLII and W5Re/W26Re.

Segment time accuracy

Within $\pm 0.02\%$ of reading

Other setting

Within $\pm 0.5\%$ of span

Insulation resistance

More than $20\text{M}\Omega$ (500V DC) between measured terminals and ground
More than $20\text{M}\Omega$ (500V DC) between power terminals and ground

Dielectric strength

1000V AC for one minute between measured terminals and ground
1500V AC for one minute between power terminals and ground

Program

Storage program pattern : Max. 2 patterns (8 segments per pattern)

Storage segments : Max. 16 segments
(Possible to link, 8 segments x 2 patterns)

Program repeat : 1 - 999 times or continuous

Level setting : See input range

Time setting : 00 hr 00 min to 99 hrs 59 min

PID constant section : 4 levels (For level PID control)

Start mode : Zero start or PV start (selectable)

Wait zone : Up, down 0 to 99°C (°F) or 0.0 to 9.9°C (°F) at going up or down

Control

Control method

- a) PID control with autotuning
b) Heat/cool PID control with autotuning

Major setting range

Setting range : Same as input range.
Heat side proportional band : 1(0.1) to setting range
(ON/OFF action when P=0)
Cool side proportional band : 1 to 1000% of heat side proportional band
Integral time : 1 to 3600sec.(P + D action when I=0)
Derivative time : 1 to 3600sec.(P + I action when D=0)
Differential gap : 0 to 100°C (°F) or 0.0 to 100.0°C (°F)
(When used with ON/OFF action)
Output limiter high : -5.0 to +105.0%
Output limiter low : -5.0 to +105.0%

Control output

Relay output : Form C contact, 250V AC 3A (resistive load)
Voltage pulse output : 0/12V DC
(Load resistance : More than 600Ω)
Current output : 0 to 20mA or 4 to 20mA DC
(Load resistance : Less than 600Ω)

Alarm

Temperature alarm (Optional)

- a) Number of alarm : 2 points
b) Alarm action
Deviation high, low, high/low, band, and process high, low alarms
Set value high, low (In contrast to the process high or low alarm, the set value high or low alarm is activated when the programmed set value goes over or under a preset value.)
c) Alarm differential gap : 0 to 10°C (°F) or 0.0 to 10.0°C (°F)
• Hold function and re-hold function can be added to deviation high low and high/low.
• Energized/de-energized alarm (selectable)

Alarm output

Relay output, Form A contact 250V AC 1A (resistive load)

Options

External contact input

Type : RESET, RUN, HOLD, STEP
Input method : Non voltage contact input
OPEN : $500\text{k}\Omega$ or more
CLOSE : 10Ω or less

Time signal output

Setting range : 00 hr 00 min to 99 hr. 59 min
Storage pattern : 2 times/pattern
Output : 1 point
Relay contact output, 250V AC 1A (resistive load)
• When "Pattern end output" is selected, "Time signal output" is not available.

Pattern end output

Setting range : 00 hr 00 min to 99 hr. 59 min
Output : 1 point
Relay contact output, 250V AC 1A (resistive load)
• When "Time signal output" is selected, "Pattern end output" is not available.

Retransmission output

Number of outputs : 1 point
Output signal : 0 to 10mV, 0 to 100mV DC
(Load resistance : More than $20\text{k}\Omega$)
0 to 1V, 0 to 5V, 0 to 10V, 1 to 5V DC
(Load resistance : More than $1\text{k}\Omega$)
0 to 20mA, 4 to 20mA DC
(Load resistance : Less than 600Ω)
Output type : Measured value (PV), Set value (SV), Manipulated output value (MV)

General specifications

External Dimensions (W x H x D)

P48 : 48 x 96 x 100mm
P96 : 96 x 96 x 100mm

Supply voltage

90 to 264V AC (Including power supply voltage variation)
[Rating : 100 to 240V AC] (50/60Hz common)

Power consumption

Less than 9VA (100 to 240V AC)

Effect by power failure

A power failure of 20ms or less will not affect the control action.
If the power failure is shorter than 2 seconds, the autotuning function (if used) will be canceled but the program continues. If the power failure is longer than 4 seconds, the controller returns to its initial status (start mode).

Operating environments : 0 to 50°C [32 to 122°F] , 45 to 85% RH

Memory backup : RAM back-up by lithium battery

Net weight

P48 : Approx. 300g
P96 : Approx. 400g

Ramp/Soak temperature controller REX-P48/96

Model and Suffix Code

Specifications	Model and Suffix Code											
Model	REX-P48 REX-P96	<input type="checkbox"/>	<input type="checkbox"/>	<input type="checkbox"/>	<input type="checkbox"/>	<input type="checkbox"/>	<input type="checkbox"/>	<input type="checkbox"/>	<input type="checkbox"/>	<input type="checkbox"/>	<input type="checkbox"/>	<input type="checkbox"/>
Control method	PID reverse control with AT PID direct control with AT Level PID reverse control with AT Level PID direct control with AT Heat/cool PID control Heat/cool level PID control	F	D	L	M	W	V					
Input type	See input range code table	<input type="checkbox"/>										
Scale range	See input range code table	<input type="checkbox"/>										
Control output (OUT1)	Relay output Voltage pulse DC current : 0 to 20mA DC current : 4 to 20mA						M V 7 8					
Control output (OUT2)	Control action : F, D, L, M Relay output Voltage pulse DC current : 0 to 20mA DC current : 4 to 20mA							No symbol M V 7 8				
Alarm 1	No alarm See alarm code table								N <input type="checkbox"/>			
Alarm 2	No alarm See alarm code table									N <input type="checkbox"/>		
Contact input	Not supplied Supplied										N Y	
Output function	Not supplied Pattern end output Time signal output											N 1 2
Analog output	Not supplied See analog output code table											N <input type="checkbox"/>

■ For REX-P48/96 with CE mark, UL and CSA approval, please add the suffix of "/CE" at the end of the model code.

Input range code

Thermocouple

Input	Code	Range
K	K : 22	-199.9 - 999.9°C
	K : 16	-200 - 1372°C
	K : B2	-199.9 - 999.9°F
	K : B3	-330 - 2500°F
J	J : 14	-199.9 - 999.9°C
	J : 15	-200 - 1200°C
	J : A9	-199.9 - 999.9°F
T	J : B1	-330 - 2192°F
	T : 01	-199.9 - 400.0°C
	T : A1	-199.9 - 752.0°F

Input	Code	Range
R	R : 02	0 - 1769°C
	R : A2	0 - 3216°F
S	S : 02	0 - 1769°C
	S : A2	0 - 3216°F
B	B : 02	0 - 1820°C
	B : A2	0 - 3308°F
E	E : 06	-200 - 1000°C
	E : A5	-330 - 1832°F
N	N : 02	0 - 1200°C
	N : A2	0 - 2372°F

Input	Code	Range
PLII	A : 02	0 - 1390°C
	A : A2	0 - 2534°F
W5Re W26Re	W : 02	0 - 2320°C
	W : A4	0 - 4208°F
U	U : 08	0 - 600°C
	U : A4	0 - 1100°F
L	L : 05	0 - 900°C
	L : A2	0 - 1600°F

RTD

Input	Code	Range
JPt100	P : 20	-199.9 - 510.0°C
	P : B6	-199.9 - 950.0°F
Pt100	D : 20	-199.9 - 660.0°C
	D : A1	-199.9 - 999.9°F

Alarm code

Code	Type
A	Deviation High
B	Deviation Low
C	Deviation High/Low
D	Band Alarm
E	Deviation High with Alarm Hold
F	Deviation Low with Alarm Hold
G	Deviation High/Low with Alarm Hold
H	Process High

Code	Type
J	Process Low
K	Process High with Alarm Hold
L	Process Low with Alarm Hold
Q	Deviation High with Alarm Re-hold
S	Deviation Low with Alarm Re-hold
T	Deviation High/Low with Alarm Re-hold
V	Set value High
W	Set value Low

Analog output code

Code	Type
1	0 - 10mV DC
2	0 - 100mV DC
3	0 - 1V DC
4	0 - 5V DC
5	0 - 10V DC
6	1 - 5V DC
7	0 - 20mA DC
8	4 - 20mA DC

* On alarm re-hold function: The alarm will become effective after it has first entered non-alarm range, when alarm set values are changed.

Ramp/Soak temperature controller REX-P48/96

External Dimensions and Rear Terminals

Unit : mm

REX-P96

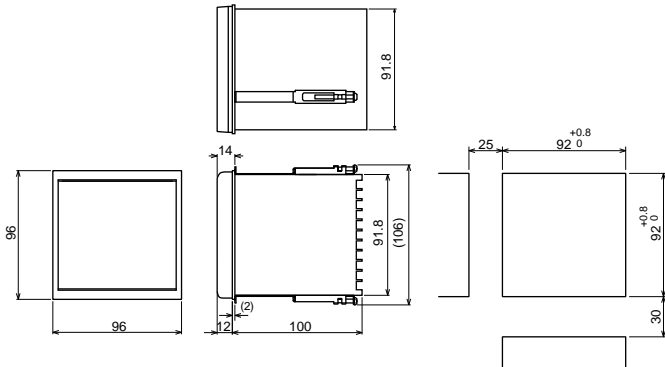

REX-P48

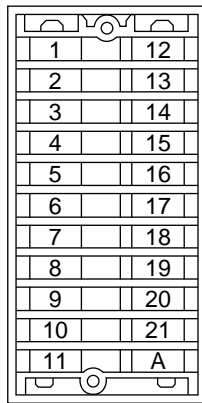
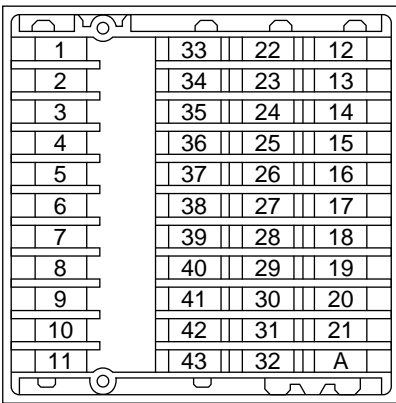
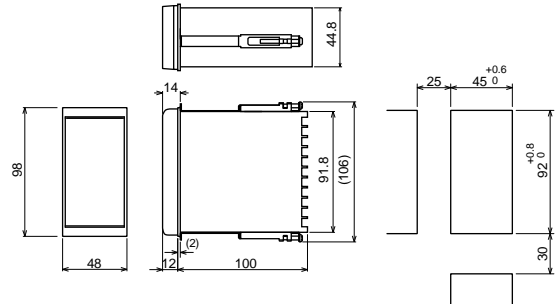

No.	Description
1	AC 100 to 240V Power supply
2	
3	Alarm output Time signal, Pattern end signal output
4	Alarm 1
5	Alarm 2
6	TS or END Relay contact output
7	(1) C → (2) + Control output : OUT2 (1) Relay contact output (2) Voltage DC/Current DC
8	NO → - Control output : OUT1 (1) Relay contact output (2) Voltage DC/Current DC
9	C → + Control output : OUT1 (1) Relay contact output (2) Voltage DC/Current DC
10	NO → - Control output : OUT1 (1) Relay contact output (2) Voltage DC/Current DC
11	NC → - Control output : OUT1 (1) Relay contact output (2) Voltage DC/Current DC

No.	Description
12	→ + Analog output
13	→ - Analog output
14	DI COM Contact input
15	○ ○ RESET RESET
16	○ ○ RUN RUN
17	○ ○ STEP STEP
18	○ ○ HOLD HOLD
19	A Measured input (1) Thermocouple (2) RTD
20	→ + Measured input (1) Thermocouple (2) RTD
21	→ + Measured input (1) Thermocouple (2) RTD
A	